

1. Gateway & Bridge Series
2. Dimming Series
3. Relay Series
4. Climate Series

---

## **5. GUEST ROOM SERIES**

### **5.5 Guest Room Module 8CH, R05A** GR0805A

---

6. Human Interface Series
7. I/O Series
8. Power Supply Series
9. Multiroom Audio Series
10. Motorization Series



## I DESCRIPTION

The Green IoT CONTROLS (Green IoT) GR0805A Guest Room Module 8CH, R05A is a GreenBUS 8 channels output device designed for multipurpose applications for areas such as office buildings, hotels, shopping malls and other spaces. Known commonly as GRMS module.

The module is provided with a status LED to indicate the load status and can be used to identify the module during system configuration. For ease of installation the module is DIN rail mounted.

The module comes equipped with a tri-state switch that allows individual local control of connected circuits/devices and for installation and testing. Each channel can be locally “locked” to disable control, making it safer for installation and maintenance than conventional automation systems.

It provides 8 channels 5A relay. Each channel is equipped with a built-in current sensor for individual energy monitoring and reporting.

The module is also coming with a dip switch that allows the Green IoT wired module to be Blue IoT CONTROLS (Blue IoT) ready enabling it to wirelessly join our meshed network system using the Green/Blue Bridge.

## | DEVICE FEATURES

Provides 8 x 5A relays.

Can be associated with 0-10V analog output modules for fluorescent dimming.

Electrical phase independence for each channel.

Tri-state switch that allows individual local control. Each channel can be locally “locked” to disable control.

Simple, sliding module connection ensures error-free GreenBUS installation.

Module's I/O can easily be swapped out via plug-in system for fast and cost-effective maintenance.

Incorporates current detection, overload, overheat and short circuit protection.

Each channel includes short circuit cut-out protection against installation wiring faults and incandescent lamp filament failure.

No earth is required.

LED indicates load status of each channel.

Remembers last known state at the hour in the event of power loss.

Incorporates Zone and Category grouping.

Built-in Scene, Sequence and Timer engines supporting up to 32 Scenes, 8 Sequences and 16 Timers.

Built-in Event engine supporting up to 32 Events with up to 8 triggers, 8 conditions and 128 actions.

32 Flags can be defined to be used as triggers and/or conditions for Event engine.

Programmable onsite or offsite via Smart IoT CONTROLS Configuration Client Software.

Programmed variables are stored in nonvolatile memory and are retained in case of loss of mains or GreenBUS power.

Digital input for fire alarm integration.

Supports local and online upgrade.

CE & RoHs certified.

## I TECHNICAL SPECIFICATIONS

Operation Voltage:	DC 24V ±10% (BUS Powered)
Power Consumption:	100mA ±10%
Channel Input:	8 Channels, 100-240 VAC ±10%/30 VDC
Channel Output:	8 Channels 5A
Working Temperature:	0°C ~ +55°C
Storage Temperature:	-10°C ~ +55°C
Working Humidity:	20% ~ 90%
Storage Humidity:	10% ~ 90%
Installation:	35mm DIN rail mounting, EN50022
Module Dimension:	111.66x116.3x80.3mm (WxHxD)
Packing Dimension:	124x125x90mm (WxHxD)
Net Weight:	544g
Gross Weight:	609g
Operation and Display:	Red and Green LED, for displaying the physical status
CE Mark:	In accordance with EMC and LVD
Protection Class:	IP20, EN60 529

## I DIMENSIONS

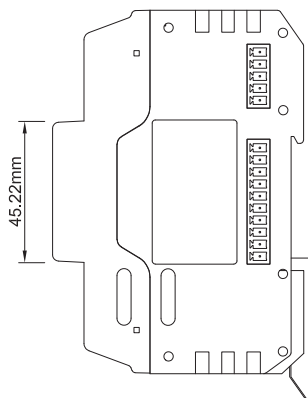

Side View

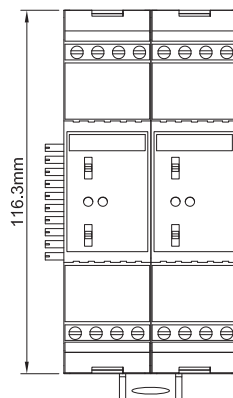

Front View

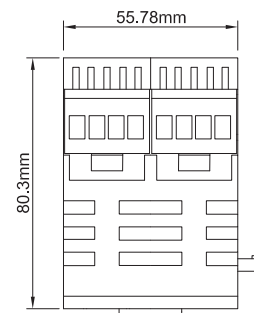

Top View

# INSTALLATION

## Step 1:

Turn the module (see Figure 1) and mount it on the 35mm DIN rail. Hook the module, top first, onto the DIN rail then gently press the bottom of the module onto the rail and ensure that it latches on firmly (see Figure 2).

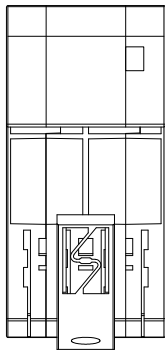

Figure 1

## Step 2:

Join the modules together by sliding them together along the DIN rail ensuring that the GreenBUS plug (see Figure 2) fully locates into the next modules GreenBUS socket (see Figure 3).

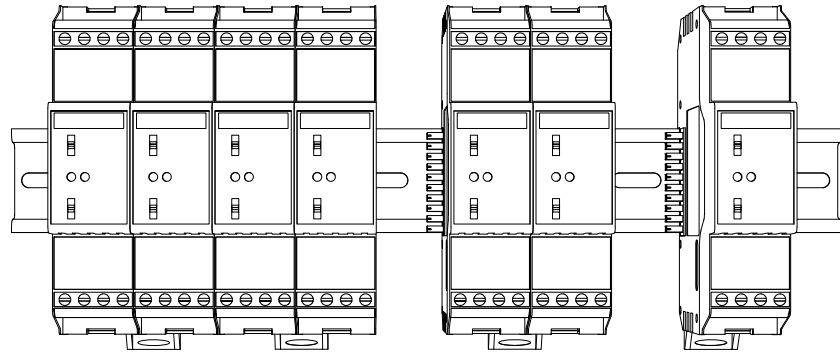

Figure 2

## Step 3:

Wire remaining terminals in accordance with wiring diagram (see Figure 4).

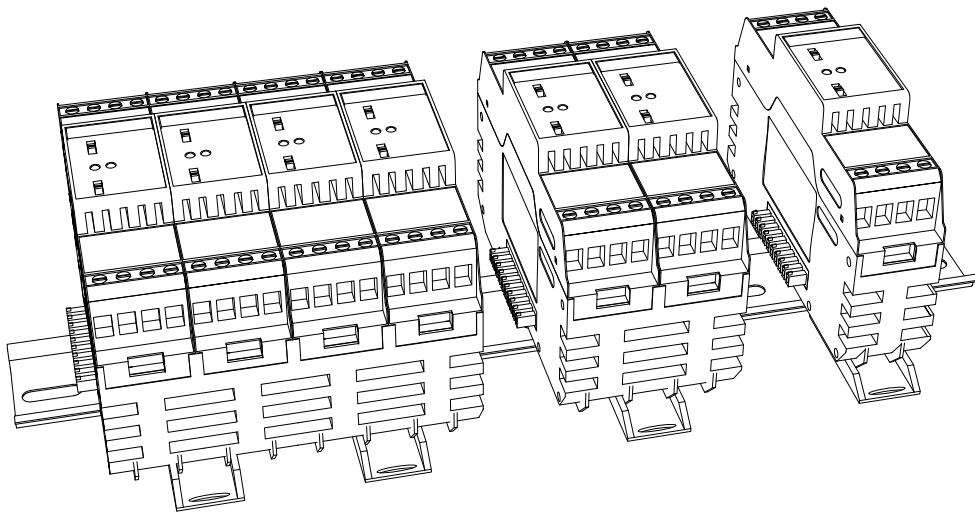
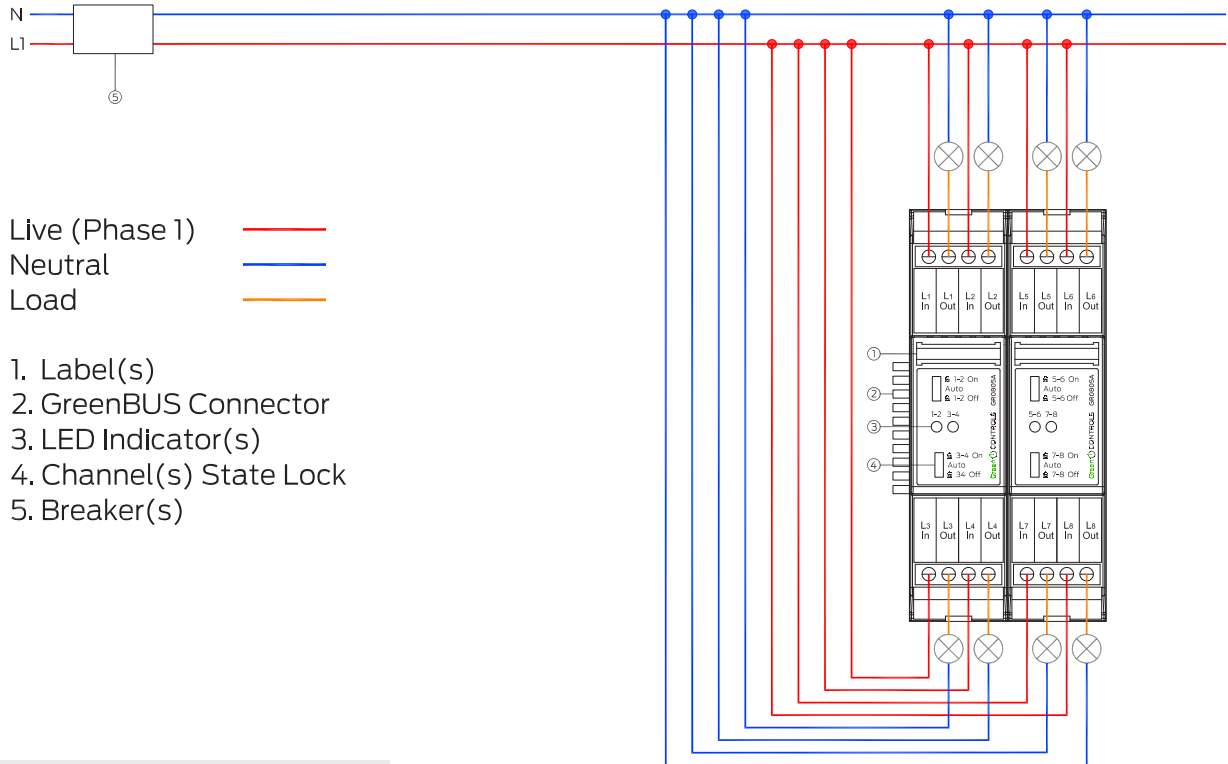

Figure 3

# WIRING DIAGRAM



**Figure 4:** Wiring Diagram

# RECOMMENDED CABLES

**Module power input cable:**

2.0mm<sup>2</sup> electrical copper wire.

**Load output wire:**

2.0mm<sup>2</sup> electrical copper wire.

**Recommended cable configuration:**

GND = Brown and White + Orange and White

B-(B)= Blue and White + Green and White

B+(A)= Blue + Green

24V = Brown + Orange

