

1. Gateway & Bridge Series
2. Dimming Series
3. Relay Series

4. CLIMATE SERIES

4.4 Climate Module, 1 CTRLR with I/O CM0604I

5. Guest Room Series
6. Human Interface Series
7. I/O Series
8. Power Supply Series
9. Multiroom Audio Series
10. Motorization Series



I DESCRIPTION

The Green IoT CONTROLS (Green IoT) CM0604I Climate Module, 1 CTRLR with I/O is a GreenBUS I/O device designed for climate control applications for areas such as office buildings, residential buildings, hotels, airports, shopping malls and other spaces.

It can control single stage machines with two operation modes (Heating and Cooling) and three fan speed operation modes (Low, Medium and High). Each controller is equipped with the option to associate with an external current sensor for energy monitoring and reporting of Cooling, Heating and Fan individually.

The module can handle FCU, AHU and VAV systems (through the analog output). In conjunction with Green IoT LCD panels, switches or multisensor (with built-in temperature sensor) it provides an elegant interface to provide an energy efficient climate control solution.

The module is provided with a status LED to indicate the load status and can be used to identify the module during system configuration.

For ease of installation the modules are DIN rail mounted. The module comes equipped with a tri-state switch that allows individual local control of connected machines for installation and testing.

Each unit can be locally “locked” to a specific state, making it safer for installation and maintenance than conventional automation systems.

With 4 inputs, comprising 3 Analog and 1 Digital, the Climate Module can be connected directly to external devices such as humidity and temperature sensors as well as being able to be connected to filter warning outputs on compatible HVAC units.

The module is also coming with a dip switch that allows the Green IoT wired module to be Blue IoT CONTROLS (Blue IoT) ready enabling it to wirelessly join our meshed network system using the Green/Blue Bridge.

| DEVICE FEATURES

5 Channels output via 1 x 10A AC changeover relay and 4 x 10A AC relays with 4 I/Os (3 Analog Inputs, 1 Digital Input and 1 Analog Output)

Supports AC/DC climate control systems.

Fan speed options: Low, Medium High and Auto.

Mode options: Heating, Cooling, Fan and Auto.

Control single stage climate control systems.

Power state, Modes and Fan speeds protection delay.

Tri-state switch that allows individual local control. Each unit can be locally "locked" to a specific state to disable control.

Simple, sliding module connection ensures error-free GreenBUS installation.

Module's I/O can easily be swapped out via plug-in system for fast and cost-effective maintenance.

No earth is required.

LED indicates load status of each channel.

Remembers last known state at the hour in the event of power loss.

Incorporates Zone and Category grouping.

Built-in Timer engines supporting up to 16 Timers.

Built-in Event engine supporting up to 32 Events with up to 8 triggers, 8 conditions and 128 actions.

32 Flags can be defined to be used as triggers and/or conditions for Event engine.

Programmable onsite or offsite via Smart IoT CONTROLS Configuration Client Software.

Programmed variables are stored in nonvolatile memory and are retained in case of loss of mains or GreenBUS power.

Digital input for fire alarm integration.

Supports local and online upgrade.

CE & RoHs certified.

TECHNICAL SPECIFICATIONS

Operation Voltage:	DC 24V ±10% (BUS Powered)
Power Consumption:	60mA ±10%
Channel Input:	2 Channels, 100-240 VAC ±10%/30 VDC with 3 Analog Inputs and 1 Digital Input
Channel Output:	4 Channels 10A, 1 Channel NC 3A/NO 5A with 1 DO
Working Temperature:	0°C ~ +55°C
Storage Temperature:	-10°C ~ +55°C
Working Humidity:	20% ~ 90%
Storage Humidity:	10% ~ 90%
Installation:	35mm DIN rail mounting, EN50022
Module Dimension:	55.78x116.3x80.3mm (WxHxD)
Packing Dimension:	65x125x90mm (WxHxD)
Net Weight:	225g
Gross Weight:	260g
Operation and Display:	Red and Green LED, for displaying the physical status
CE Mark:	In accordance with EMC and LVD
Protection Class:	IP20, EN60 529

DIMENSIONS

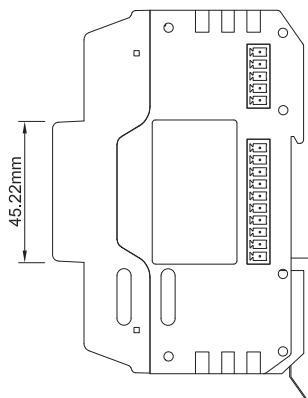

Side View

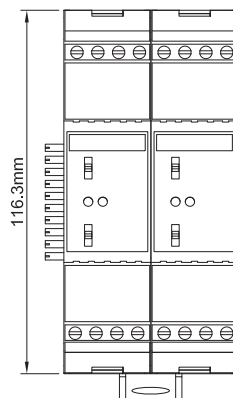

Front View

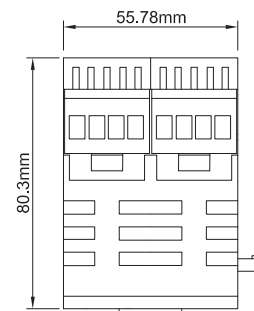

Top View

INSTALLATION

Step 1:

Turn the module (see Figure 1) and mount it on the 35mm DIN rail. Hook the module, top first, onto the DIN rail then gently press the bottom of the module onto the rail and ensure that it latches on firmly (see Figure 2).

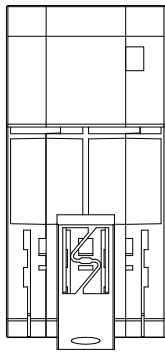

Figure 1

Step 2:

Join the modules together by sliding them together along the DIN rail ensuring that the GreenBUS plug (see Figure 2) fully locates into the next modules GreenBUS socket (see Figure 3).

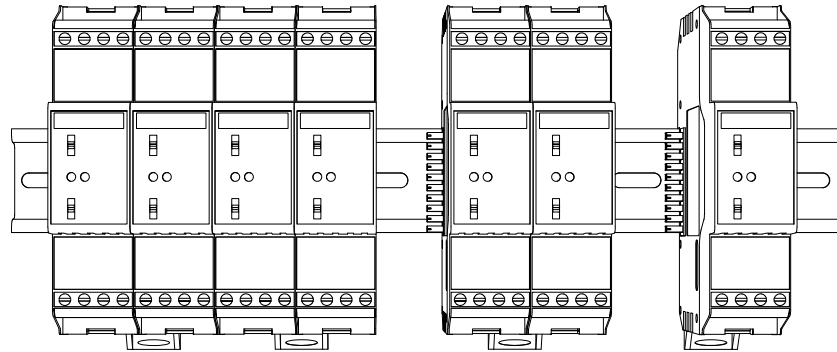

Figure 2

Step 3:

Wire remaining terminals in accordance with wiring diagram (see Figure 4).

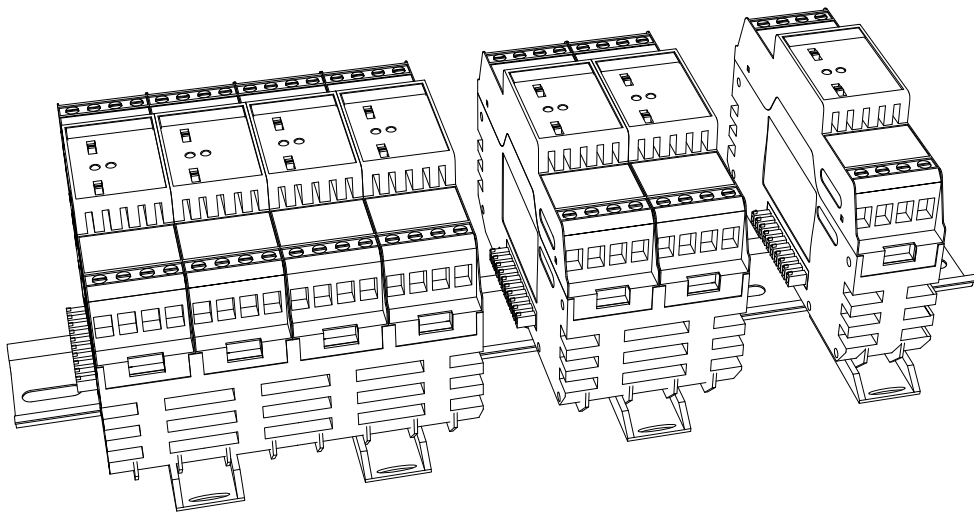

Figure 3

WIRING DIAGRAM

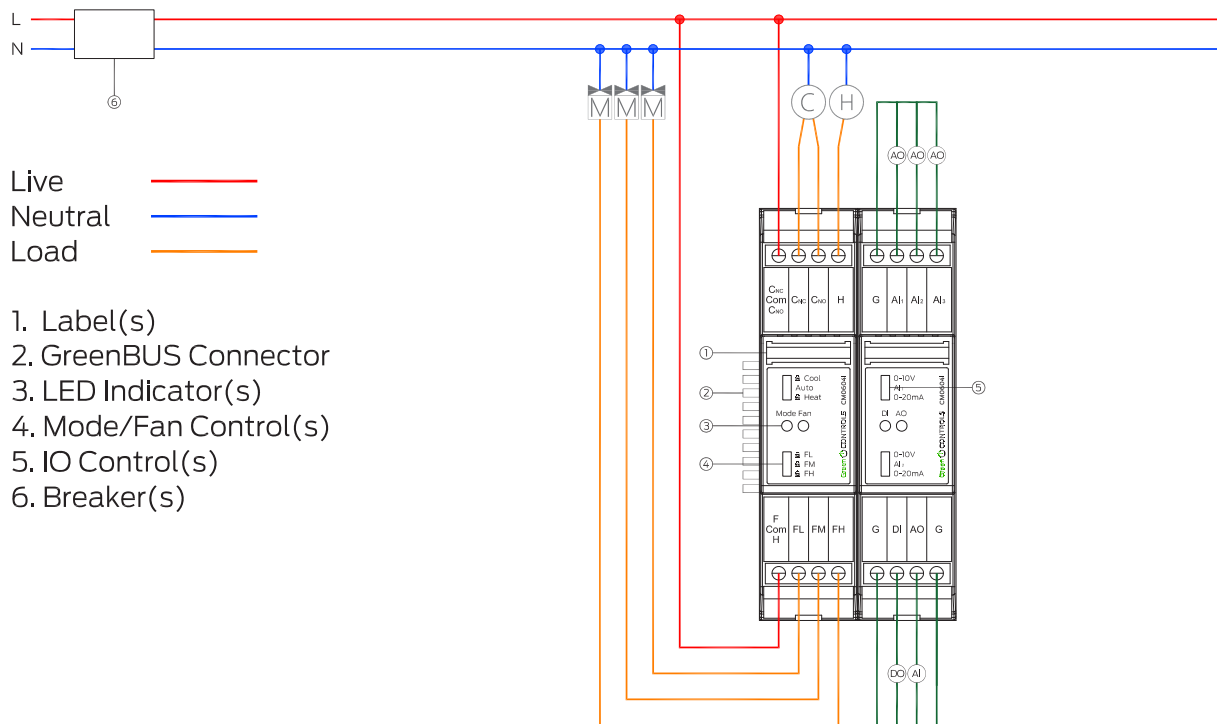

Figure 4: Wiring Diagram

RECOMMENDED CABLES

Module power input cable:

2.0mm² electrical copper wire.

Load output wire:

2.0mm² electrical copper wire.

Recommended cable configuration:

GND = Brown and White + Orange and White

B-(B)= Blue and White + Green and White

B+(A)= Blue + Green

24V = Brown + Orange

